

Equinox

DVD2012E

User Manual

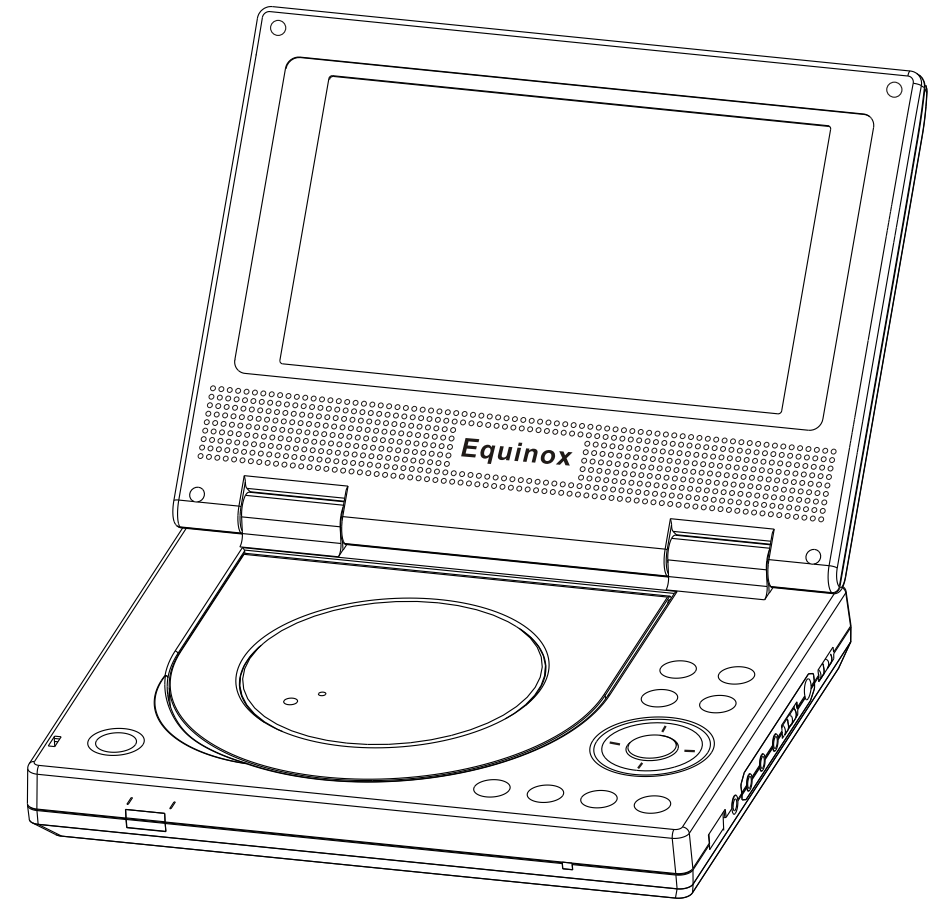

Please read this User Manual carefully to ensure proper use of this product and keep this manual for further reference.

Content

Introduction

■ Safety Precautions	2
■ Important Safety Instructions	3
■ Panel Illustration	5
■ Remote Control	6

Connections

■ Connecting to a TV set	7
■ Connecting to an AV Receiver with Digital Audio Input	8

Basic Playback

■ Basic Operation	9
-------------------------	---

Advanced Features

■ Modes and Features Setup	10
■ Remote Control Operation	15
■ MP3 Playback	24
■ KODAK Picture CD playback	25

Others

■ Troubleshooting	26
■ Specifications	27
■ Macrovision function instruction	27

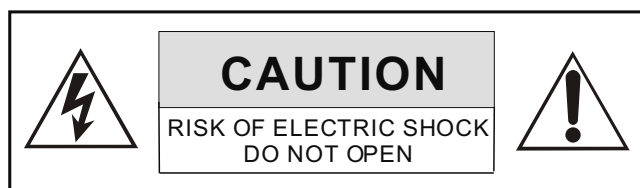

THE LIGHTNING FLASH WITH ARROWHEAD SYMBOL WITHIN AN EQUILATERAL TRIANGLE IS INTENDED TO ALERT THE USER TO THE PRESENCE OF UNINSULATED "DANGEROUS VOLTAGE" WITHIN THE UNIT'S CABINET THAT MAY BE OF SUFFICIENT MAGNITUDE TO CONSTITUTE A RISK OF ELECTRIC SHOCK TO PERSONS.



THE EXCLAMATION POINT WITHIN AN EQUILATERAL TRIANGLE IS INTENDED TO ALERT THE USER TO THE PRESENCE OF IMPORTANT OPERATING AND MAINTENANCE (SERVICING) INSTRUCTIONS IN THE MANUAL ACCOMPANYING THE UNIT.

WARNING:

TO PREVENT FIRE OR ELECTRIC SHOCK, DO NOT EXPOSE THE UNIT TO RAIN OR MOISTURE. NEVER ATTEMPT TO OPEN THE CABINET, DANGEROUS HIGH VOLTAGES ARE PRESENTED IN THE UNIT. REFER SERVICING TO QUALIFIED SERVICE PERSONNEL.

CAUTION:

TO PREVENT ELECTRIC SHOCK, MATCH WIDE- BLADE PLUG WITH WIDE SLOT AND FULLY INSERT. THE APPARATUS SHALL NOT BE EXPOSED TO WATER AND NO OBJECTS FILLED WITH LIQUID SUCH AS VASES SHALL BE PLACED ON THE APPARATUS.

CAUTION:

THE UNIT EMPLOYS A LASER SYSTEM. TO ENSURE THE PROPER USE OF THE UNIT, READ THIS MANUAL CAREFULLY AND KEEP IT FOR FUTURE REFERENCE.

IF THE UNIT REQUIRES SERVICING, CONTACT THE SELLER OR SEE "TROUBLESHOOTING".

TO PREVENT DIRECT EXPOSURE TO THE LASER RADIATION, DO NOT OPEN THE CABINET. VISIBLE LASER MAY RADIATE WHEN THE CABINET IS OPENED OR THE INTERLOCKS ARE DEFEATED. DO NOT STARE INTO THE LASER BEAMS.

CAUTION:

THE DVD VIDEO PLAYER IS A CLASS 1 LASER PRODUCT. USE OF CONTROLS OR ADJUSTMENTS OR PERFORMANCE OF PROCEDURES OTHER THAN THOSE SPECIFIED HEREIN MAY RESULT IN HAZARDOUS RADIATION EXPOSURE. AS THE LASER BEAM USED IN THIS DVD VIDEO PLAYER IS HARMFUL TO THE EYES, DO NOT ATTEMPT TO DISASSEMBLE THE CABINET. REFER SERVICING TO QUALIFIED PERSONNEL ONLY.

WARNING:

FCC REGULATIONS STATE THAT ANY CHANGE OR MODIFICATION TO THE EQUIPMENT, NOT EXPRESSLY APPROVED BY MAKER OR ITS AUTHORIZED PARTIES, COULD VOID USER'S AUTHORITY TO OPERATE THIS EQUIPMENT.

Type	
Model	DVD2012E
Play mode	NTSC/PAL
Disc mode	DVD, CD, MP3, CD-R, CD-RW, HDCD, JPEG, DVD-R/W
Video characteristic	
Video S/N ratio	≥65dB
Resolution	≥500 lines
Audio characteristic	
Frequency response	fs 96KHz: 20Hz-20KHz: +/-1dB
Audio S/N ratio	≥90dB
Dynamic range	≥90dB
Distortion	< 0.01%
D/A Converter	96KHz/24bit
Output characteristic	
Video output	1Vp-p(75)
Audio output	COAXIAL, 2CH
Power Voltage	DC IN 12V
Power consumption	≤10W
Size	205x158x40mm
Weight	0.7kg

Specifications are subject to change without notice.

Accessories:

- 1. Remote controller 1 pcs
 - 2. Audio/Video cable 1 pcs
 - 3. Users manual 2 pcs
 - 4. Adapter 1 pcs
 - 5. Car Adapter 1 pcs
- (check that all accessories are included)

If you have any questions, please consult the troubleshooting guide below.

NO PICTURE OR SOUND

- Ensure the power button is on.
- Ensure the power outlet is operational.
- Ensure the power cord is not damaged.
- Ensure the power plug is connected firmly to the outlet.

PICTURE BUT NO SOUND

- Ensure the audio jacks are securely connected.
- Ensure the audio connector is not damaged.
- Ensure the volume is turned up in VOL/CH setup.
- Ensure you have set the player's AUDIO settings correctly.
- Ensure you have ENTERed the correct AV input for your TV.
- Ensure the audio is not set to mute.

SOUND BUT NO PICTURE

- Ensure the video jacks are securely connected.
- Ensure you have ENTERed the correct AV input for your TV.
- Ensure the video connector is not damaged.
- Ensure you have set the player's VIDEO settings correctly.

POOR PICTURE OR SOUND

- Ensure you have set the player's AUDIO settings correctly.
- Ensure the disc is not scratched or stained.
- Ensure the AV connector or the output terminal is not damaged.

"BAD DISC" DISPLAYED

- Ensure the disc is not warped, damaged or deformed.
 - Ensure the disc is not badly stained or damaged.
 - Ensure the disc format is compatible with the player.
 - Please check whether you have tried to play a software CD.
- If so, please restart the player.

REMOTE NOT WORKING

- Ensure the remote batteries are working.
- Point the remote control directly at the player's IR sensor.
- Remove any obstacles between the remote and the IR sensor.

UNIT NOT WORKING

- Turn off the power, and then turn it on again.

"NO DISC" DISPLAYED

- Ensure you have put the disc on the tray.
- Ensure the disc is not upside down.
- Ensure the disc is not distorted, stained or scratched.

1. Read Instructions

All the safety and operating instructions should be read before the product is operated.

2. Retain Instructions

The safety and operating instructions should be retained for future reference.

3. Heed Warnings

All warnings on the product and in the operating instructions should be adhered to.

4. Follow Instructions

All operating instructions should be followed.

5. Cleaning

Unplug this product from the wall outlet before cleaning. Do not use liquid cleaners or aerosol cleaners. Use a damp cloth for cleaning.

6. Attachments

Do not use attachments not recommended by the product manufacturer as they may cause hazards.

7. Water and Moisture

Do not use this product near water for example, near a bathtub, wash bowl, kitchen sink, or laundry tub; in a wet basement; or near a swimming pool; and the like.

8. Accessories

Do not place this product on an unstable cart, stand, tripod, bracket, or table. The product may fall, causing serious injury to a child or adult, and serious damage to the product. Use only with a cart, stand, tripod, bracket, or table recommended by the manufacturer, or sold with the product. Any mounting of the product should follow the manufacturer's instructions, and should use a mounting accessory recommended by the manufacturer.

9. Portable Cart Warning

A product and cart combination should be moved with care. Quick stop, excessive force, and uneven surface may cause the product and cart combination to overturn.



(Symbol provided by RETAC)

10. Ventilation

Slots and openings in the cabinet are provided for ventilation and to ensure reliable operation of the product and to protect it from overheating, and these openings must not be blocked or covered. The openings should never be blocked by placing the product on a bed, sofa, rug, or other similar surface. This product should not be placed in a built-in installation such as a bookcase or rack unless proper ventilation is provided or the manufacturer's instructions have been adhered to.

11. Power Sources

This product should be operated only from the type of power source indicated on the marking label. If you are not sure of the type of power supply to your home, consult your product dealer or local power company. For products intended to operate from battery power or other sources, refer to the operating instructions.

12. Grounding or Polarization

This product may be equipped with a polarized alternating current line plug (a plug having one blade wider than the other). This plug will fit into the power outlet only one way. This is a safety feature. If you are unable to insert the plug fully into the outlet, try reversing the plug. If the plug should still fail to fit, contact your electrician to replace your obsolete outlet. Do not defeat the safety purpose of the polarized plug.

13. Power Cord Protection

Power supply cords should be routed so that they are not likely to be walked on or pinched by items placed upon or against them, paying particular attention to cords at plugs, convenience receptacles, and the point where they exit from the product.

14. Outdoor Antenna Grounding

If an outside antenna or cable system is connected to the product, be sure the antenna or cable system is grounded so as to provide some protection against voltage surges and built-up static charges. Article 810 of the National Electrical Code, ANSI/NFPA 70, provides information with regard to proper grounding of the mast and supporting structure, grounding of the lead-in wire to an antenna discharge unit, size of grounding conductors, location of antenna discharge unit, connection to grounding electrodes, and requirements for the grounding electrode. See figure below.

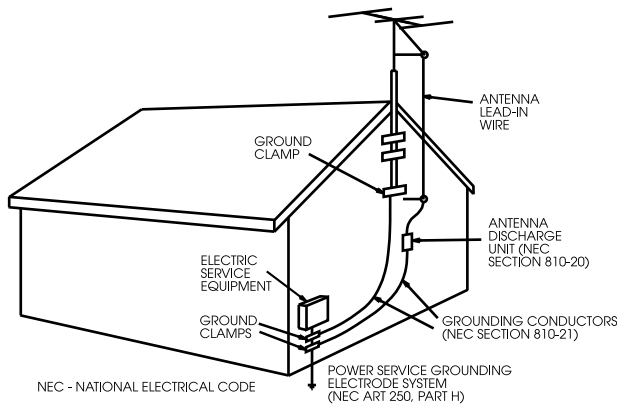

15. Lightning

For added protection for this product during a lightning storm, or when it is left unattended and unused for long periods of time, unplug it from the wall outlet and disconnect the antenna or cable system. This will prevent damage to the product due to lightning and power lines surges.

16. Power Lines

An outside antenna system should not be located in the vicinity of overhead power lines or other electric light or power circuits, or where it can fall into such power lines or circuits. When installing an outside antenna system, extreme care should be taken to keep from touching such power lines or circuits as contact with them might be fatal.

17. Overloading

Do not overload wall outlets, extension cords, or integral convenience receptacles, as this can result in a risk of fire or electric shock.

18. Object and Liquid Entry

Never push objects of any kind into this product through openings as they may touch dangerous voltage points or short-out parts that could result in a fire or electric shock. Never spill liquid of any kind on the product.

19. Servicing

Do not attempt to service this product yourself as opening or removing covers may expose you to dangerous voltage or other hazards. Refer all servicing to qualified service personnel.

20. Damage Requiring Service

Unplug this product from the wall outlet and refer servicing to qualified service personnel under the following conditions:

- A) When the power-supply cord or plug is damaged,
- B) If liquid has been spilled, or objects have fallen into the product,
- C) If the product has been exposed to rain or water,
- D) If the product does not operate normally by following the operating instructions. Adjust only those controls that are covered by the operating instructions as an improper adjustment of other controls may result in damage and will often require extensive work by a qualified technician to restore the product to its normal operation,
- E) If the product has been dropped or damaged in any way.
- F) When the product exhibits a distinct change in performance this indicates a need for service.

21. Replacement Parts

When replacement parts are required, be sure the service technician has used replacement parts specified by the manufacturer or have the same characteristics as the original part. Unauthorized substitutions may result in fire, electric shock, or other hazards.

22. Safety Check

Upon completion of any service or repairs to this product, ask the service technician to perform safety checks to determine that the product is in proper operating condition.

23. Wall or Ceiling Mounting

The product should be mounted to a wall or ceiling only as recommended by the manufacturer.

24. Heat

The product should be situated away from heat sources such as radiators, heat registers, stoves, or other products (including amplifiers) that produce heat.

The introduction of KODAK Picture CD

A Kodak Picture CD has the size and shape of a regular CD. You can order a KODAK Picture CD simply by checking the box on the photo finishing envelope when you drop off a roll of film (35 mm or Advanced Photo System (APS) color print film) at the time of processing in Kodak Express store displaying "Kodak Picture CD" sign. When your order is returned, you receive your prints, negatives, and your full roll of pictures safely stored on your KODAK Picture CD. Each KODAK Picture CD brings you the tools to enhance, share and manage your pictures on your computer. You also can record the JPEG picture into CD-R or CD-RW with the CD-Rewriter yourself.

- Note:**
1. The Max. Size of JPEG Picture can be supported: 3840X3840 pels
 2. JPEG stands for Joint Picture Experts Group. It is the first International Standard on Still Picture Compressing: ISO 10918-1, constituted by the Committee on Still Picture Compressing Standard of ISO. The pictures on KODAK Picture CD are stored in this format (JPEG). This player can decode the JPEG pictures in KODAK Picture CD and playback the pictures in different modes.

Now, you can playback Kodak Picture CDs on this player and view your wonderful pictures on your TV in the comfort of your living room.

When a Kodak Picture CD is inserted on a player an automatic slide show is launched. Each picture in the Kodak Picture CD will be displayed consecutively in a slide-show fashion and will be scaled to fit in the whole TV screen.

General function:

- You can set slideshow transition modes for any pictures.
- Press **PAUSE** to stop playing.
- Press **◀** or **▶** to see the previous or next picture.
- Press **PLAY** to continue slideshow transitions.
- Press **STOP** to return to root menu.

Image Rotation

There are three modes to rotate a picture: original, 90 Deg, and 180 Deg. These operations are allowed only when a picture is being displayed normally and will be cancelled automatically when a new picture is displayed. The **ANGLE** keys are used to select the different rotation modes:

- Press **ANGLE** OSD display original.
- Press **ANGLE** again OSD display 90 Deg.
- Press **ANGLE** again OSD display 180 Deg.

Zoom Function:

This player provides both Zoom in/out and Zoom pan function. Press the **ZOOM** consecutively, the picture will zoom in/out in turn as followings:

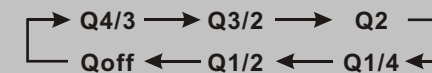

- Note:** During the ZOOM function, slideshow transitions and image rotation are disabled.
Q off: close zoom, press **PLAY** again to resume slideshow transition mode.

Supported formats

- Disc format: ISO 9660, Joliet
- Music file format: MP3
- MP3 bit rate (data rate): 32 -192 kbps
- Total number of music files and albums: around 350 per disc.
- Sampling rate: (CBR)32kHz/44. 1kHz/48kHz/64kHz; (VBR) 16kHz/22kHz/24kHz/32kHz (MPEG)

Note: The player will not identify or play MP3 discs under the following conditions: recording format is not supported, badly scratched or deformed disc, MP3 recorded in CD-R or CD-RW which is not finalized, or a dirty pickup.
When a MP3 disc is loaded, the screen will display as follows:

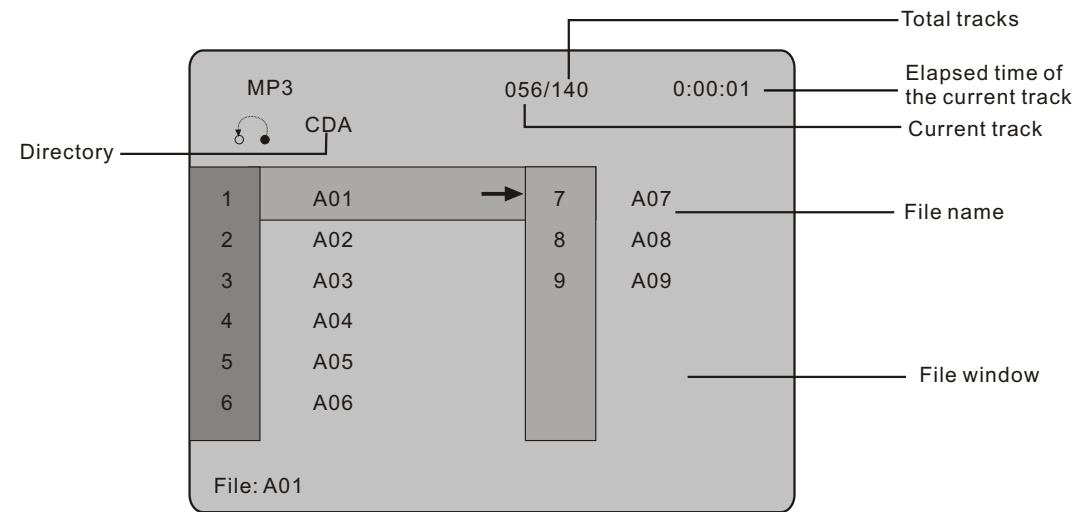

Press \uparrow/\downarrow to select the file when the cursor appears in the file window.
Press **ENTER** to play the current file selected by the cursor.
Press \leftarrow/\rightarrow to switch between the directory window and the file window.
Note: During MP3 playback, **Forward Scan** and **Reverse Scan** are not available.

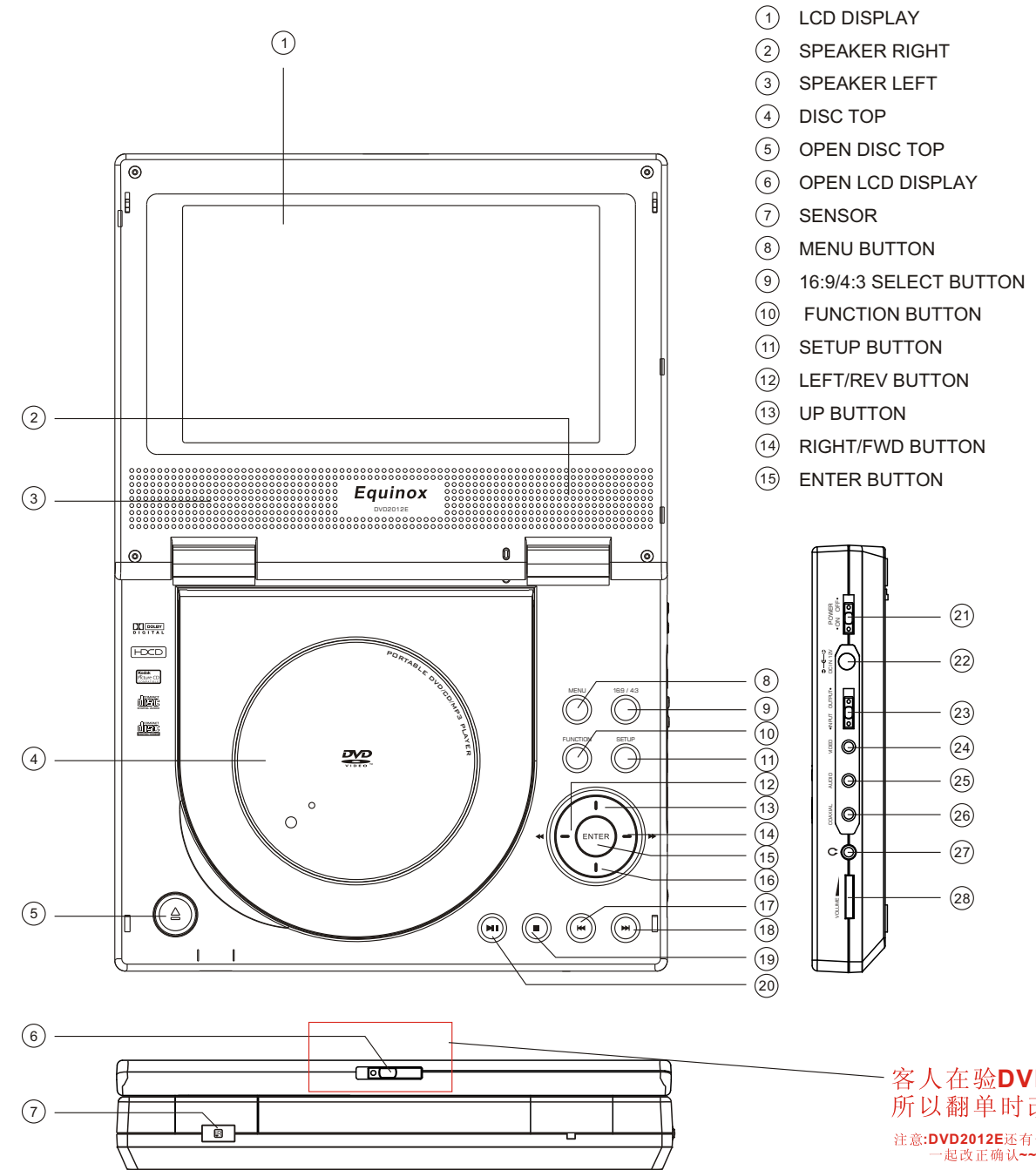

客人在验DVD2012E时说这里不对, 所以翻单时改正在让客人确认。
注意: DVD2012E还有一种文字的说明书,也是同样的问题, 一起改正确认~~

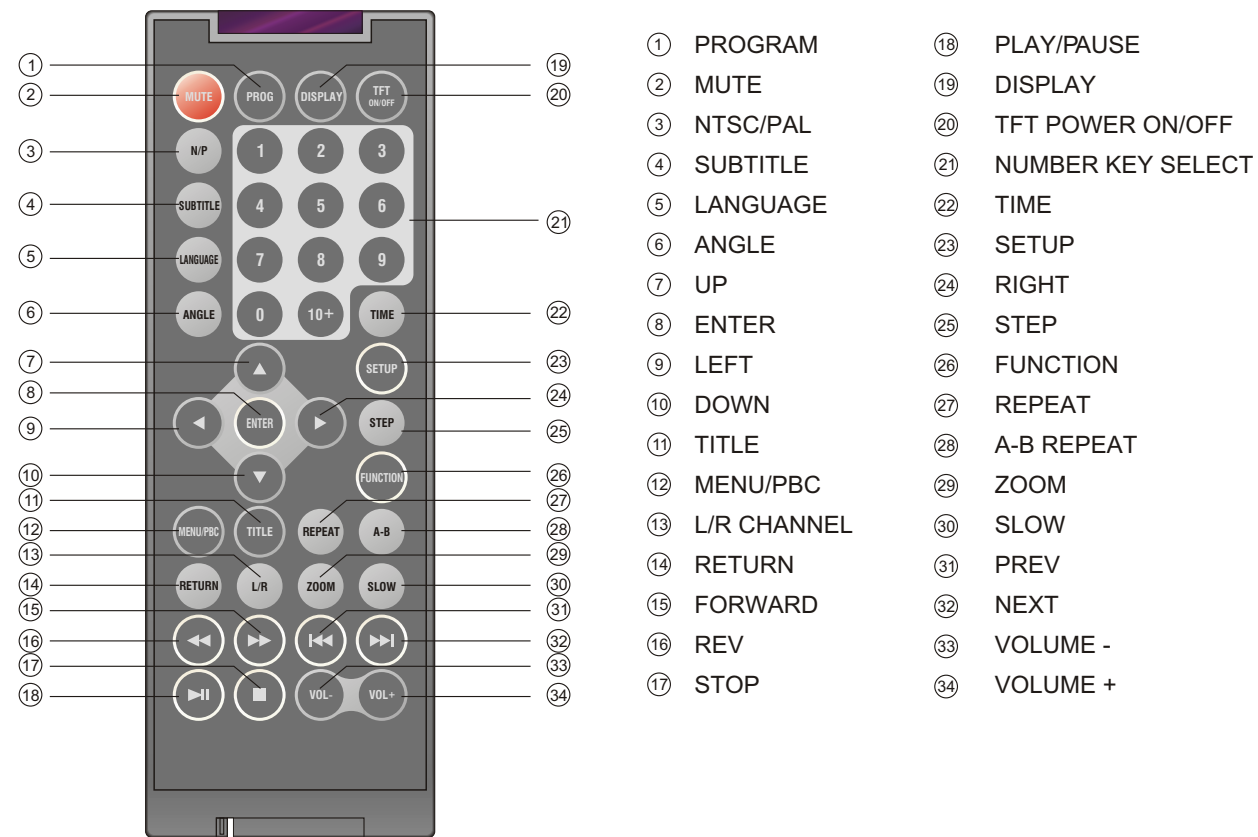

Using the Remote Control

Point the remote control at the remote sensor in order for the player to function correctly. The remote will function to approximately 21' from the remote sensor at an angle of approximately 30 each direction.

Note: Directing the remote sensor toward any light source, such as direct sunlight, may cause the unit to malfunction. Do not spill water or put wet items on the remote control. Never disassemble remote control.

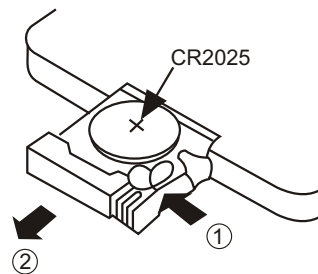

HOW TO REPLACE THE BATTERY

- STEP 1: PUSH THE BUTTON TOWARD LEFT;
- STEP 2: PULL THE BATTERY LOADER OUT.

BATTERIES

INCORRECT USE OF BATTERIES MAY CAUSE THEM TO LEAK, CORRODE OR EXPLODE.

- ◆ Be sure to place the batteries in the correct direction.
- ◆ It is dangerous to charge/heat/open or short-circuit the batteries.
- ◆ Do not leave dead or expired batteries or mix old/new batteries.
- ◆ When not using the remote control for a long duration of time, remove the batteries. When operating range becomes reduced, replace all batteries with new, fresh ones.
- ◆ If leakage from the battery occurs, wipe the battery liquid from the battery compartment, then replace.

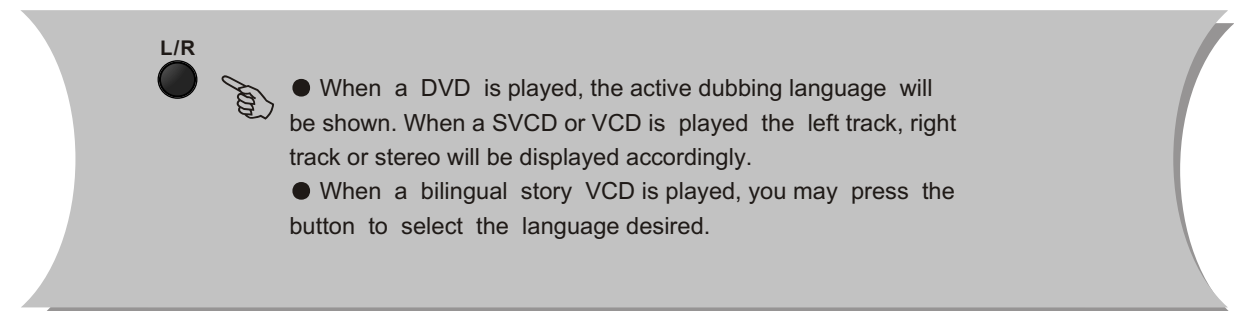
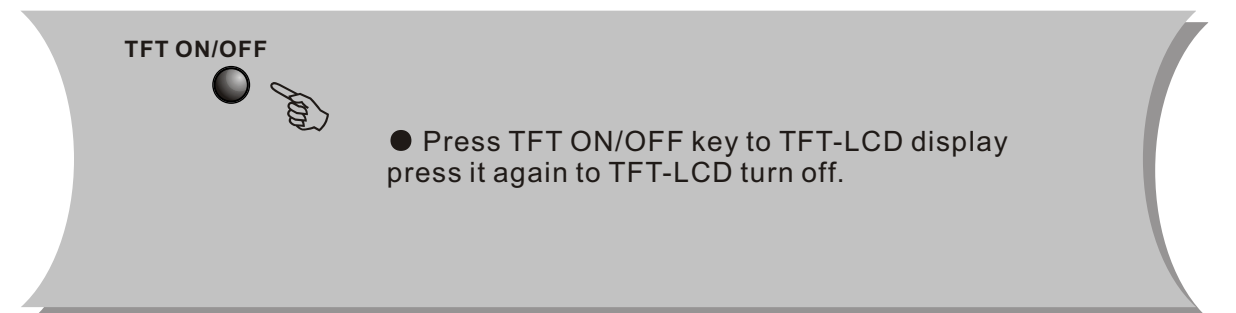
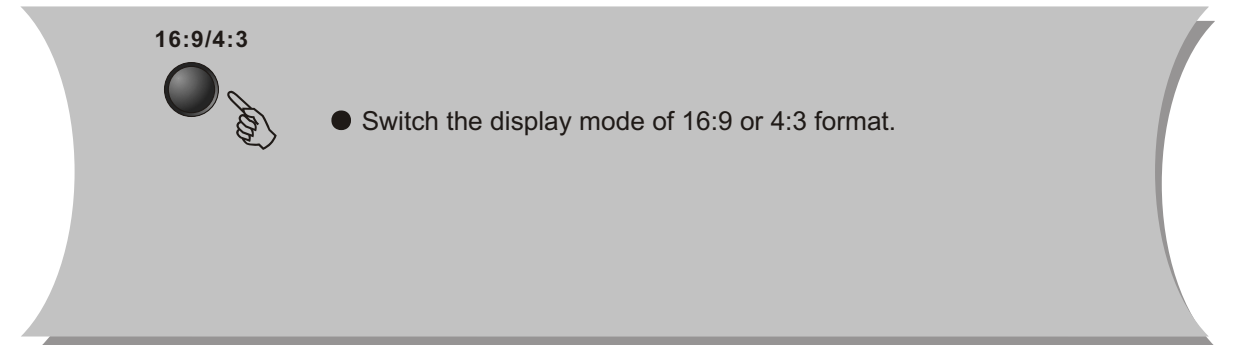

ZOOM



● During DVD playback, press **ZOOM** to magnify the image as follows:

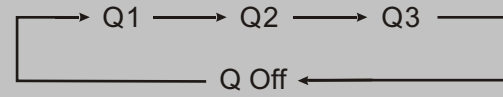

ANGLE



During DVD playback

- Press **ANGLE** to view scenes from different camera angles.
- Press **ANGLE** repeatedly to change from one camera angle to another.

Note: This function is disc specific.

LANGUAGE



During DVD playback

- Press **LANGUAGE** repeatedly to select from up to 8 audio languages/formats.

Note: This function is disc specific.

SUBTITLE



During DVD playback

- Press **SUBTITLE** repeatedly to select from up to 32 subtitle languages.

Note: This function is disc specific (languages will vary)

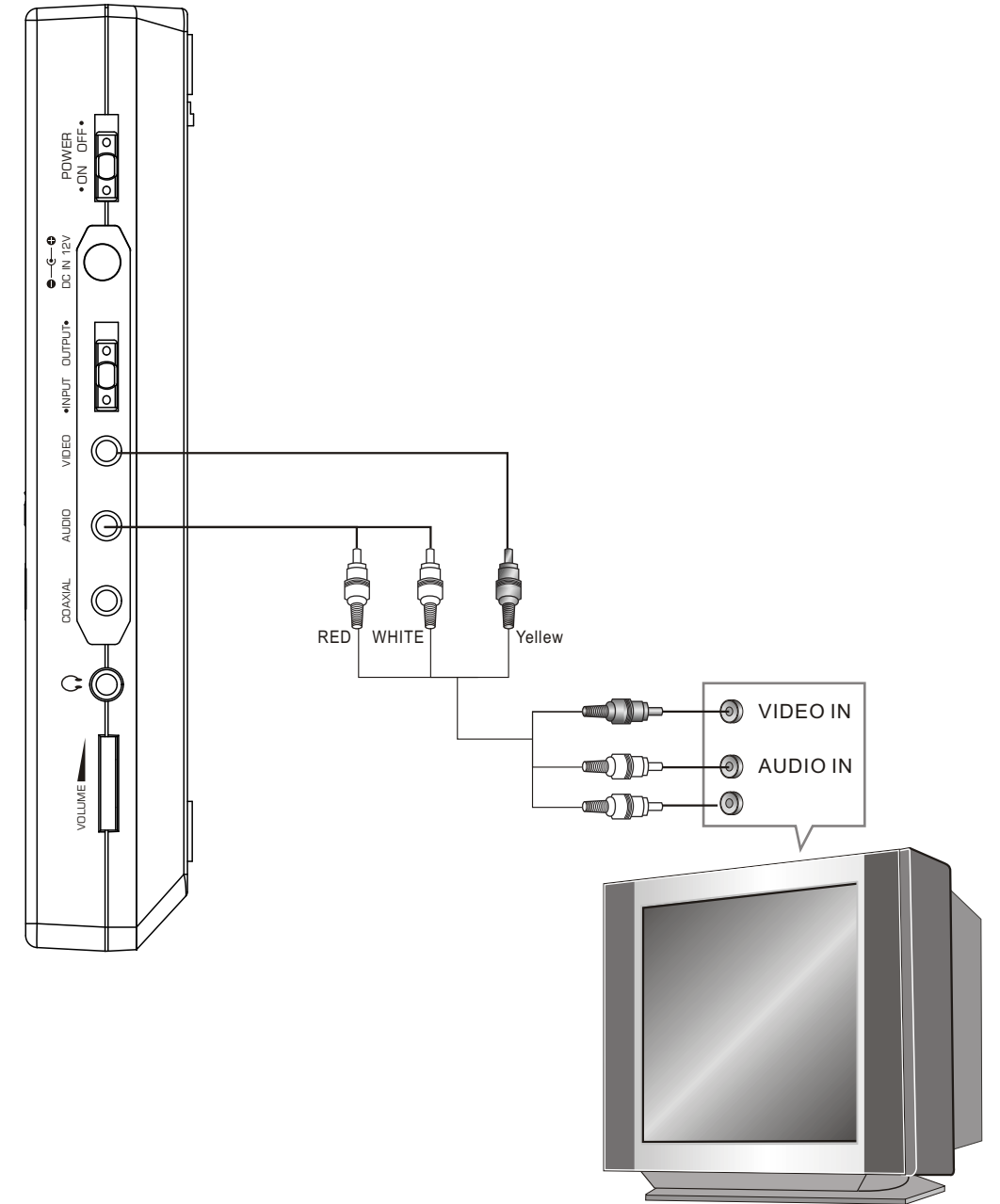

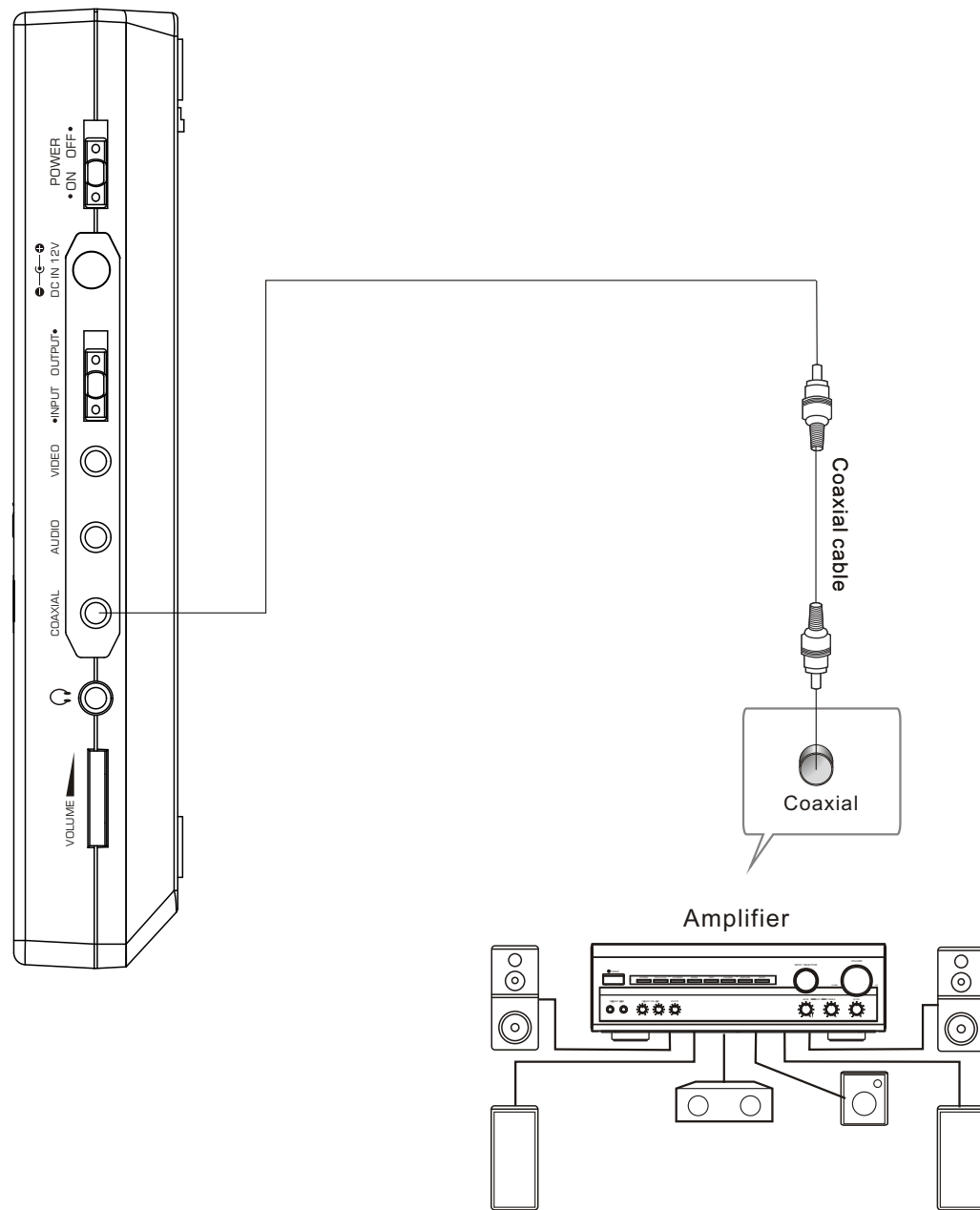

Notes:

1. Select the Coaxial digital audio output.
2. Set the player's audio out to **Raw** or **PCM** mode .
3. Set the Amplifier to the AV input connected to the DVD player.

STEP



- Press **STEP** during playback to pause playback.
- Press **STEP** repeatedly to play frame.
- Press **play** to resume normal playback.

REPEAT



- Select to press **REPEAT** to select Repeat Title, Repeat chapter, Repeat off During DVD playback.
- Press **REPEAT** to select Repeat Single, Repeat All and Repeat off (CD or Others).

VOL+ VOL-



- Press Volume **<VOL+>** button to increase Volume
- Press **<VOL->** button to reduce volume till to no volume output.

MUTE



- Press **MUTE** to mute the Audio output
- Press **MUTE** again to resume normal audio output



While [PROGRAM] is on, press ENTER to display the [Program] submenu:

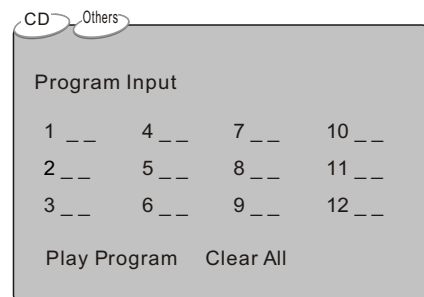

Input the track numbers in the order you would like them to play. When finished, select [Play Program] and then press ENTER to play the tracks in the new programmed order. Select [Clear All] and press ENTER to clear all the numbers you have input.

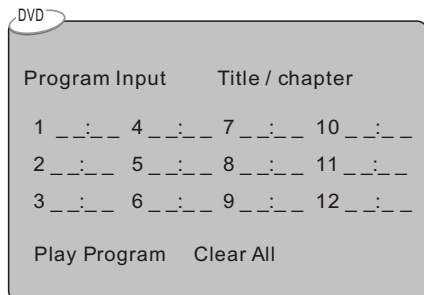

Input the title number and the chapter number in the desired order. Then select [Play Program] and press ENTER to play the chapters in the order you have set. Select [Clear All] and press ENTER to clear all the numbers you have input.

Function



- Push the Function button once, the following menu show in the display screen: Sharpness, TINT, Color, Contrast, Brightness, Rest and push the Function again select the Parameter you wanted. Press the UP ▲ button or DOWN ▼ button adjust the parameter till available.

Preparation before playing:

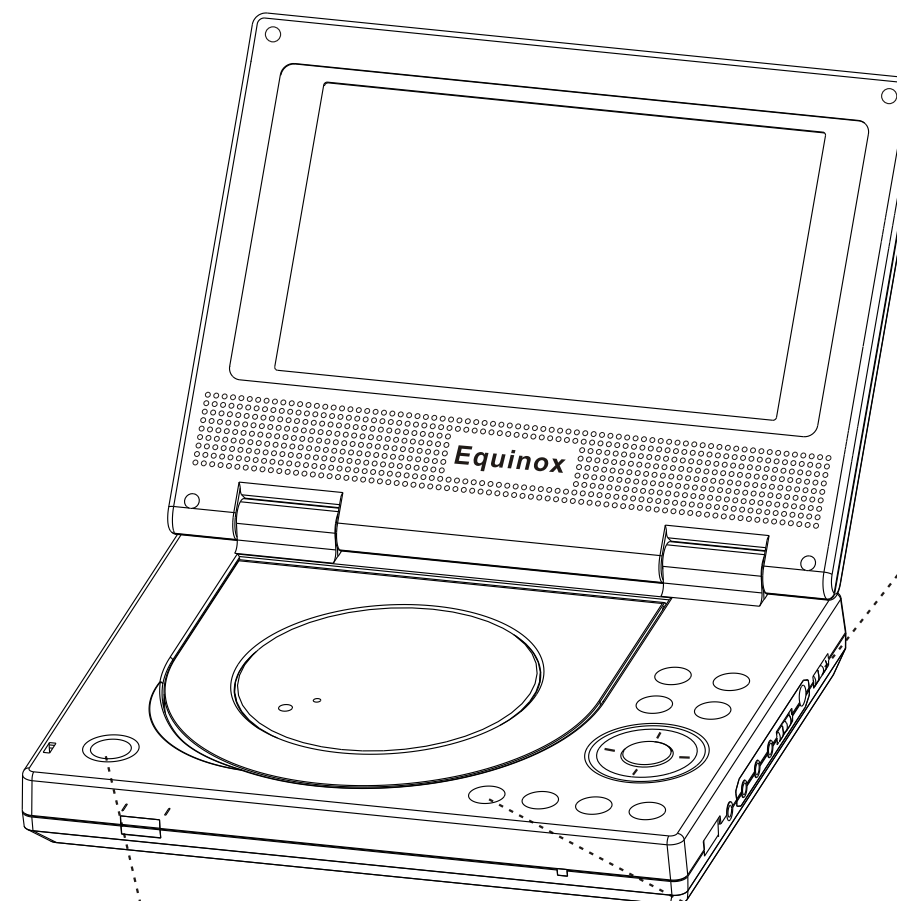

STEP 1 - Press POWER to start the player. The DVD logo appears on the TV screen.

STEP 2 - Push OPEN either on the front panel. When the tray is opened, place the disc on the tray with the label side up. Push OPEN again to close the disc tray.

STEP 3 - Press the PLAY button on the front panel or remote control. The player will automatically read and identify the disc, and begin playback.

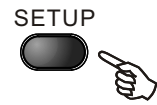

In stop mode, press **SETUP**, and the TV screen will display the Setup Menu as follows:

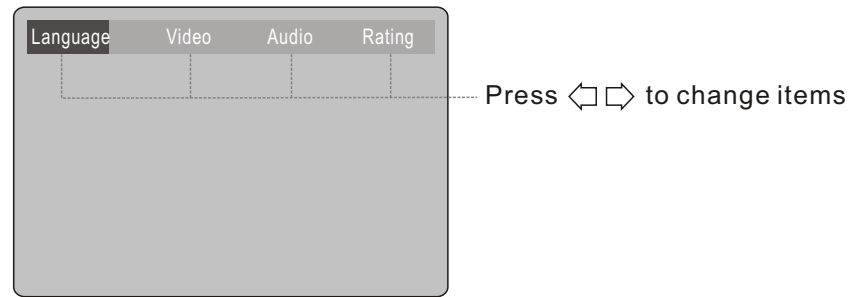

Setup Menu

- A. Press **ENTER** to display each submenu
- B. Press **SETUP** to exit the Setup Menu

Language Setup

Select [Language] in the Setup Menu, and press **ENTER** to display the [Language] submenu:

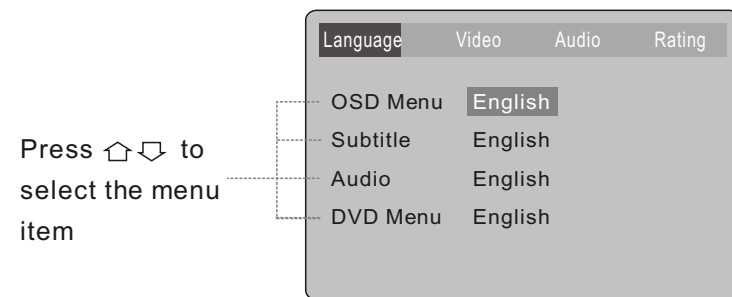

- A. Press **ENTER** or **<right>** to set
- B. Press **<left>** to go back one menu
- C. Press **<left>** OR **<up>** repeatedly to return to the Setup Menu

Select [OSD Menu], and press **ENTER** or **<right>** to display the [OSD Menu] submenu:

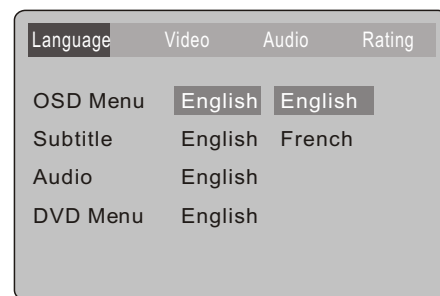

- A. Press **ENTER** to confirm.
- B. Press **SETUP** to exit the Setup Menu.

PLAY/PAUSE

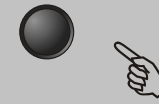

- Press **PLAY** from stop mode to start playback.
- Press **PAUSE** during playback to pause playback.
- Press **PLAY** to resume normal playback.

This function is not available if the elapsed time of current track is less than 10 seconds.

Note: MP3 discs and some DVD discs do not have a 10 second review feature.

MENU/PBC



- During DVD, playback, press **MENU** to return to the program menu.
- In the Setup Menu, press **MENU** to return to the main menu or stop mode.
- Any time, press **MENU** to cancel the current OSD or some menus

Note: This function is subject to the disc.

TITLE



- During DVD playback, press **TITLE** to display the DVD title menu or play the first title.

Note: This function is subject to the disc.

SLOW



- Press **slow** repeatedly to slow motion playback at variable speeds.

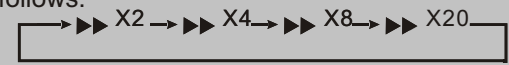

- During DVD or CD playback, press and hold **▶▶** to scan forward. The player will review the disc at 2, 4, 8 and 20 times normal speed as follows:
 
- Press **PLAY** to resume normal playback.

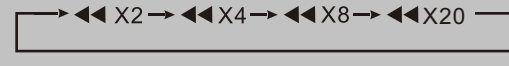

- During DVD or CD playback, press and hold **◀◀** to scan in reverse. The player will review the disc at 2, 4, 8 and 20 times normal speed as follows:
 
- Press **PLAY** to resume normal playback.

PREV



- Press **PREV** to skip to previous chapter or track.

NEXT



- Press **NEXT** to skip to the next chapter or track.

Language Setup

Select [Subtitle], and press **ENTER** or **⇨** to display the [Subtitle] submenu:

Language	Video	Audio	Rating
OSD Menu	English		
Subtitle	English	English	
Audio	English	French	
DVD Menu	English	Auto	Off

Press **⇧** **⇩** to change your selection
Note: Subtitle languages vary by disc.

- A. Press **ENTER** to confirm
- B. Press **SETUP** to exit the Setup Menu

Select [Audio], and press **ENTER** or **⇨** to display the [Audio] submenu:

Language	Video	Audio	Rating
OSD Menu	English		
Subtitle	English		
Audio	English	English	
DVD Menu	English	French	

Press **⇧** **⇩** to change your selection
Note: Audio languages vary by disc.

- A. Press **ENTER** to confirm
- B. Press **SETUP** to exit the Setup Menu

Select [DVD Menu], and press **ENTER** or **⇨** to display the [DVD Menu] submenu:

Language	Video	Audio	Rating
OSD Menu	English		
Subtitle	English		
Audio	English		
DVD Menu	English	English	French

Press **⇧** **⇩** to change your selection
Note: Menu languages vary by disc.

- A. Press **ENTER** to confirm
- B. Press **SETUP** to exit the Setup Menu

Video Setup

Select [Video] in the Setup Menu, and press ENTER to display the [Video] submenu:

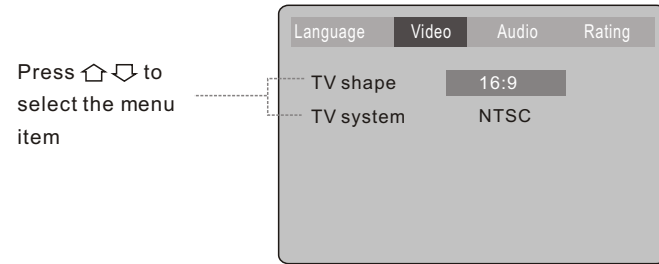

- A. Press ENTER or to set
- B. Press to return to the Setup Menu

Select [TV shape], and press ENTER or to display the [TV shape] submenu:

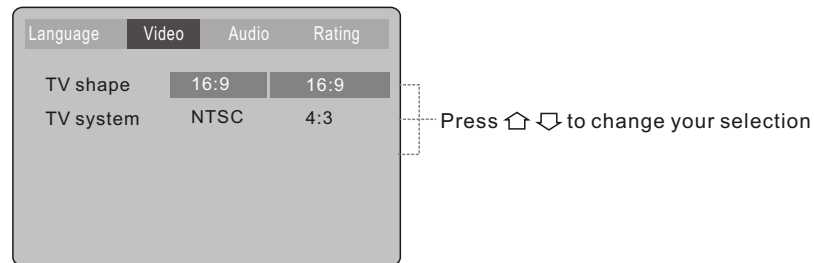

- A. Press ENTER to confirm
- B. Press SETUP to exit the Setup Menu

[4:3] -Letter Box refers to pictures where black bands appear at the top and bottom.

[16:9] -The picture fills the screen of a wide-screen (16:9) television.

Note: Not all DVDs offer movies in Full Screen format. If not, the disc will override your TV Display setting and the movie will be displayed in Letterbox format.

Select [TV system] and press ENTER or to display the [TV system] submenu:

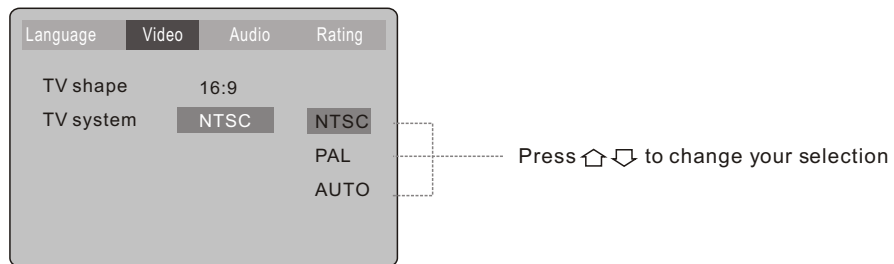

- A. Press ENTER to confirm
- B. Press SETUP to exit the Setup Menu.

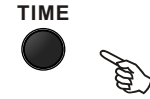

During playback, press TIME, and the [Track Search] menu will display as follows:

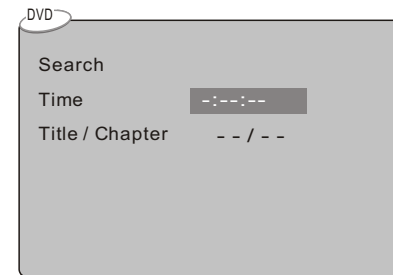
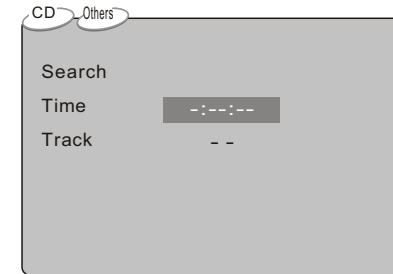

- Notes:**
- ① Time searches for an exact time in the movie.
 - ② In Title/Chapter mode, you cannot SELECT a value outside the range of the total number of titles or chapters.
 - ③ For some DVD discs, the Search function is unavailable.

Use the number keys to input the desired Time, Title or Chapter, then press ENTER to confirm.

Press TIME again, the [Disc Search] menu will display as follows:

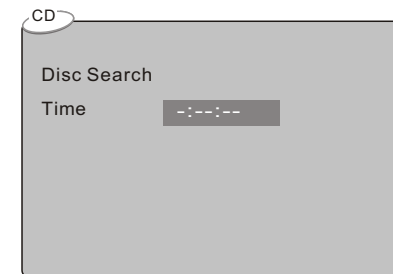

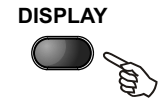

During playback, press DISPLAY to display the current time counter position.

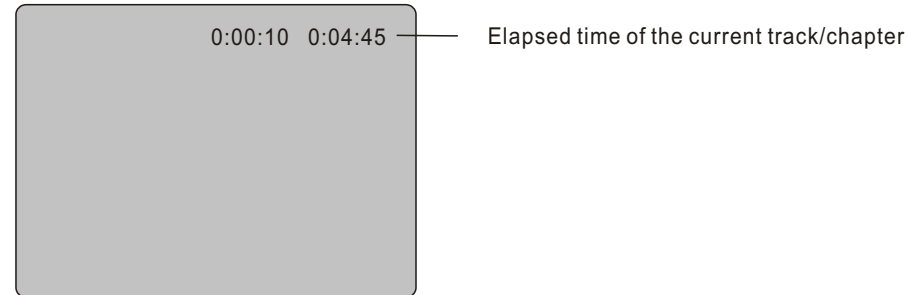

Press DISPLAY again to display additional information about the playing disc.

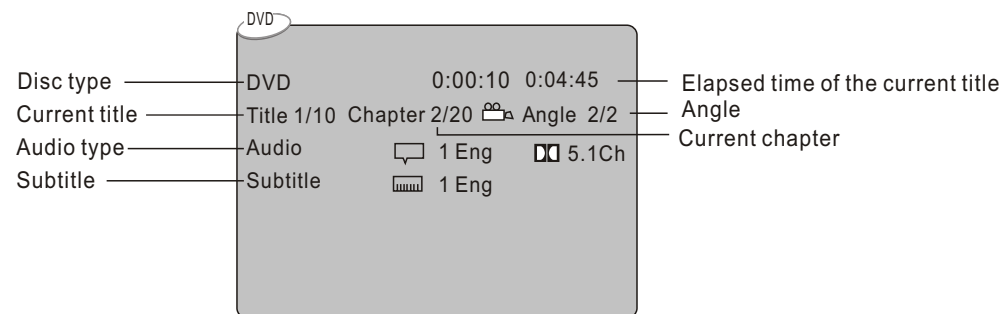
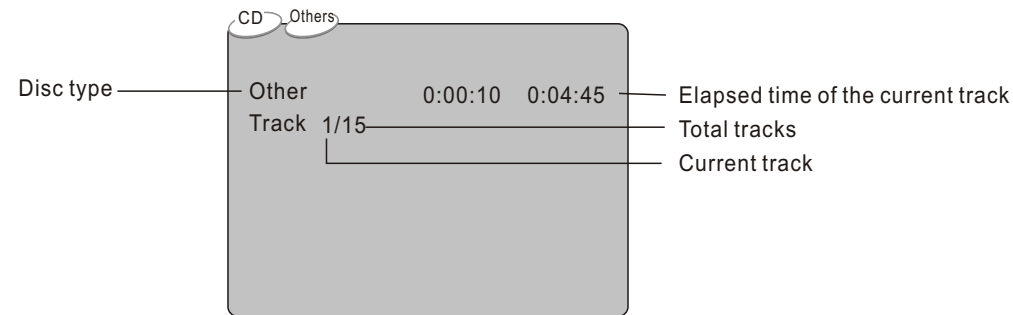

AUDIO SETUP

Digital Output

Digital out: In this setup item, you can choose the digital output (SPDIF output).

Set Digital out to:

PCM To output 2 channel digital from the Coaxial digital audio outputs; e.g., to a Minidisc recorder.

RAW To output the raw 5.1 channel digital bitstream from the coaxial digital audio outputs; e.g., to an external amplifier.

Off To disable digital out.

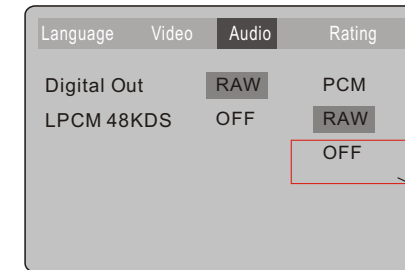

客人在验DVD2012E时说取消OFF这个词,所以下次在翻单,在让业务部确认和软硬件沟通.

LPCM 48KDS

This option sets the audio output format sent using the units optical digital audio output or you can turn on/off function.

in the linear PCM setting, "on" means "the digital audio output maximum sampling rate is 48KHz" Therefore, when the title's encoding sampling rate is 96KHz, the output will be forced converted to 48KHz.

If "off" is selected, then the maximum output sampling rate is 96KHz and no conversion will take place.

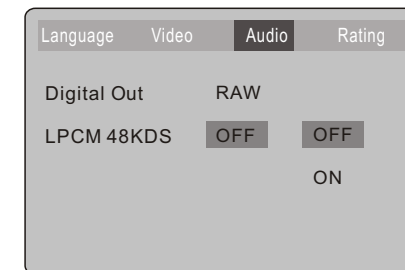

Rating Setup

The Rating menu allows you to block playback of DVDs based on their ratings.

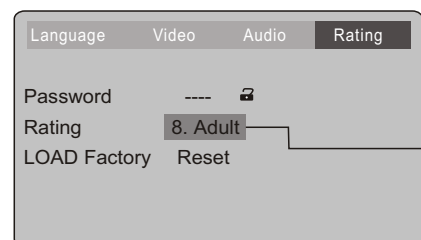

- 1:Kid Safe
- 2:G
- 3:PG
- 4:PG-13
- 5:PG-R
- 6:R
- 7:NC-17
- 8:Adult

Setting the Password & Rating Level

The DVD player allows you to block playback of inappropriate content with a password-protected Rating system (not all discs are rated).

- A. From Stop mode, press SETUP.
- B. Select Rating and press ENTER.
- C. Select Rating and press ENTER repeatedly to set the rating from 1 (most restrictive) to 8(least restrictive).

If a password has already been set, the lock icon will be closed. You will not be able to select Rating until you SELECT the correct password using the 0-9 keys.

- D. Select Password.
- E. Use the 0-9 keys to SELECT a 4-digit password and press ENTER. The lock icon will close to indicate that the rating and password are set.
- F. Press SETUP to save and exit.

Not all DVDs are rated.

DVDs that are rated higher than the level you select will not play without SELECTING the correct password.

If you forget your Rating password, select 8888 to clear the memory. Keep this password out of reach of children as it will always unlock the Parental Control setting.

0-10+ keys



- These keys are used to input the time, as well as title, chapter and track numbers.
- When a numeric item is displayed on the screen, press the 0-10+ keys to select the desired entry, and press ENTER to confirm.

A-B



- During playback, press **A-B** to select point A.
- Press it again to select point B. The player will repeat the section from A to B automatically.
- Press **A-B** third time to cancel A-B repeat and clear points A and B.

- Note:**
1. During CD playback, points A and B must be within the same track. During DVD playback, points A and B can be selected from different chapters.
 2. This function is subject to the disc.

STOP



- Press **STOP** during playback to stop and hold playback.
- Press **RUSEME** to resume playback from the point you pressed STOP.

Note: The screen saver will automatically turn on if playback is stopped about 5 minutes (when Screen Saver is set to on).